



High Quality Audio , J-FET Input, Dual Operational Amplifier

The **MUSES01** is a dual J-FET input high quality audio operational amplifier, which is optimized for high-end audio and professional audio applications with advanced circuitry and layout, unique material and assembled technology by skilled-craftwork.

It is the best for audio preamplifiers, active filters, and line amplifiers with excellent sound.

■ FEATURES

- | | |
|-----------------------|----------------------------------|
| ●Operating Voltage | Vopr=±9V to ±16V |
| ●Output noise | 9.5nV/√Hz at f=1kHz |
| ●Input Offset Voltage | 0.8mV typ. 5mV max. |
| ●Input Bias Current | 200pA typ. 800pA max. at Ta=25°C |
| ●Voltage Gain | 105dB typ. |
| ●Slew Rate | 12V/μs typ. |
| ●Bipolar Technology | |
| ●Package Outline | DIP8 |

■ PIN CONFIGURATION

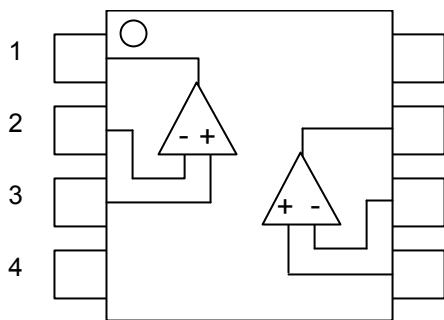

PIN FUNCTION

- | | |
|---|-------------|
| 8 | 1. A OUTPUT |
| 7 | 2. A -INPUT |
| 6 | 3. A +INPUT |
| 5 | 4. V- |
| | 5. B +INPUT |
| | 6. B -INPUT |
| | 7. B OUTPUT |
| | 8. V+ |

■ PACKAGE OUTLINE

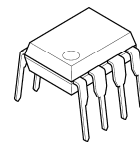

MUSES01



MUSES and this logo are trademarks of New Japan Radio Co., Ltd.

MUSES01

■ ABSOLUTE MAXIMUM RATINGS (Ta=25°C)

PARAMETER	SYMBOL	RATING	UNIT
Supply Voltage	V ⁺ /V ⁻	±18	V
Common Mode Input Voltage	V _{ICM}	±15 (Note1)	V
Differential Input Voltage	V _{ID}	±30	V
Power Dissipation	P _D	910	mW
Output Current	I _O	±25	mA
Operating Temperature Range	T _{opr}	-40 to +85	°C
Storage Temperature Range	T _{stg}	-50 to +150	°C

(Note1) For supply Voltages less than ±15 V, the maximum input voltage is equal to the Supply Voltage.

■ RECOMMENDED OPERATING CONDITION (Ta=25°C)

PARAMETER	SYMBOL	TEST CONDITION	MIN.	TYP.	MAX.	UNIT
Supply Voltage	V ⁺ /V ⁻	-	±9	-	±16	V

■ ELECTRIC CHARACTERISTICS

DC CHARACTERISTICS (V⁺/V⁻=±15V, Ta=25°C unless otherwise specified)

PARAMETER	SYMBOL	TEST CONDITION	MIN.	TYP.	MAX.	UNIT
Operating Current	I _{cc}	No Signal, R _L =∞	-	8.5	12.0	mA
Input Offset Voltage	V _{IO}	R _s ≤10kΩ (Note2)	-	0.8	5.0	mV
Input Bias Current	I _B	(Note2, 3)	-	200	800	pA
Input Offset Current	I _{IO}	(Note2, 3)	-	100	400	pA
Voltage Gain	A _V	R _L ≥2kΩ, V _o =±10V	90	105	-	dB
Common Mode Rejection Ratio	CMR	V _{ICM} =±8V (Note4)	60	75	-	dB
Supply Voltage Rejection Ratio	SVR	V ⁺ /V ⁻ =±9.0 to ±16.0V (Note2, 5)	70	83	-	dB
Max Output Voltage 1	V _{OM1}	R _L =10kΩ	±12	±13.5	-	V
Max Output Voltage 2	V _{OM2}	R _L =2kΩ	±10	±12.5	-	V
Input Common Mode Voltage Range	V _{ICM}	CMR≥60dB	±8	±9.5	-	V

(Note2) Measured at V_{ICM}=0V

(Note3) Written by the absolute rate.

(Note4) CMR is calculated by specified change in offset voltage. (V_{ICM}=0V to +8V and V_{ICM}=0V to -8V)

(Note5) SVR is calculated by specified change in offset voltage. (V⁺/V⁻=±9V to ±16V)

AC CHARACTERISTICS ($V^+V^-=\pm 15V$, $T_a=25^\circ C$ unless otherwise specified)

PARAMETER	SYMBOL	TEST CONDITION	MIN.	TYP.	MAX.	UNIT
Gain Bandwidth Product	GB	$f=10kHz$	-	3.3	-	MHz
Unity Gain Frequency	f_T	$A_V=+100, R_S=100\Omega,$ $R_L=2k\Omega, C_L=10pF$	-	3.0	-	MHz
Phase Margin	ϕ_M	$A_V=+100, R_S=100\Omega,$ $R_L=2k\Omega, C_L=10pF$	-	60	-	deg
Input Noise Voltage1	V_{NI}	$f=1kHz, A_V=+100,$ $R_S=100\Omega$	-	9.5	-	nV/ \sqrt{Hz}
Input Noise Voltage2	V_{N2}	RIAA, $R_S=2.2k\Omega,$ $30kHz$ LPF	-	1.2	3.0	μV_{rms}
Total Harmonic Distortion	THD	$f=1kHz, A_V=+10,$ $R_L=2k\Omega, V_o=5V_{rms}$	-	0.002	-	%
Channel Separation	CS	$f=1kHz, A_V=-+100, R_S=1k\Omega,$ $R_L=2k\Omega$	-	150	-	dB
Positive Slew Rate	+SR	$A_V=1, V_{IN}=2V_{p-p},$ $R_L=2k\Omega, C_L=10pF$	-	12	-	V/ μs
Negative Slew Rate	-SR	$A_V=1, V_{IN}=2V_{p-p},$ $R_L=2k\Omega, C_L=10pF$	-	13	-	V/ μs

MUSES01

■ Application Notes

•Package Power, Power Dissipation and Output Power

IC is heated by own operation and possibly gets damage when the junction power exceeds the acceptable value called Power Dissipation P_D . The dependence of the MUSES01 P_D on ambient temperature is shown in Fig 1. The plots are depended on following two points. The first is P_D on ambient temperature 25°C, which is the maximum power dissipation. The second is 0W, which means that the IC cannot radiate any more. Conforming the maximum junction temperature T_{jmax} to the storage temperature T_{stg} derives this point. Fig.1 is drawn by connecting those points and conforming the P_D lower than 25°C to it on 25°C. The P_D is shown following formula as a function of the ambient temperature between those points.

$$\text{Dissipation Power } P_D = \frac{T_{jmax} - T_a}{\theta_{ja}} \text{ [W]} \quad (T_a=25^\circ\text{C to } T_a=150^\circ\text{C})$$

Where, θ_{ja} is heat thermal resistance which depends on parameters such as package material, frame material and so on. Therefore, P_D is different in each package.

While, the actual measurement of dissipation power on MUSES01 is obtained using following equation.

$$(\text{Actual Dissipation Power}) = (\text{Supply Voltage } V_{DD}) \times (\text{Supply Current } I_{DD}) - (\text{Output Power } P_o)$$

The MUSES01 should be operated in lower than P_D of the actual dissipation power.

To sustain the steady state operation, take account of the Dissipation Power and thermal design.

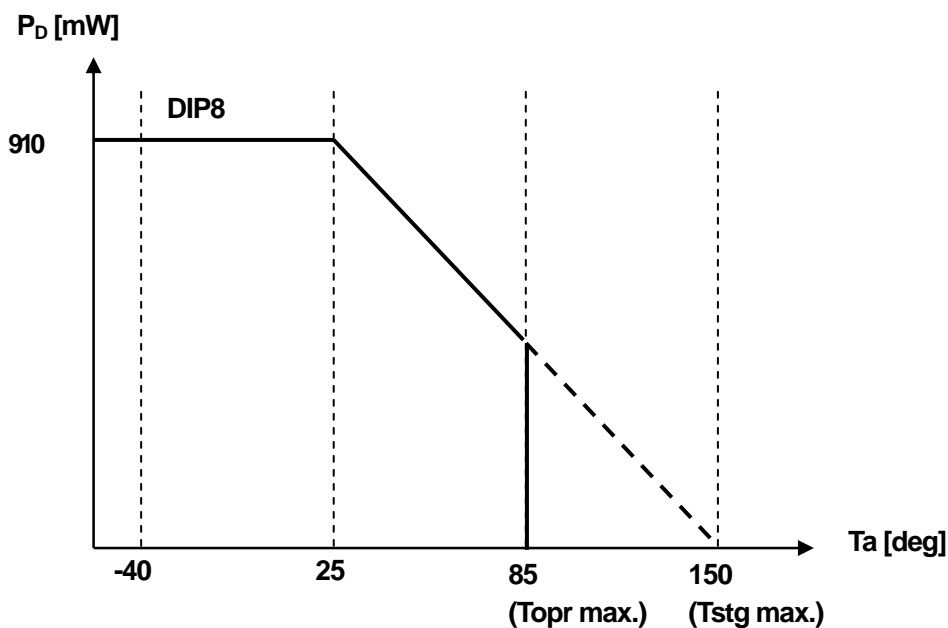
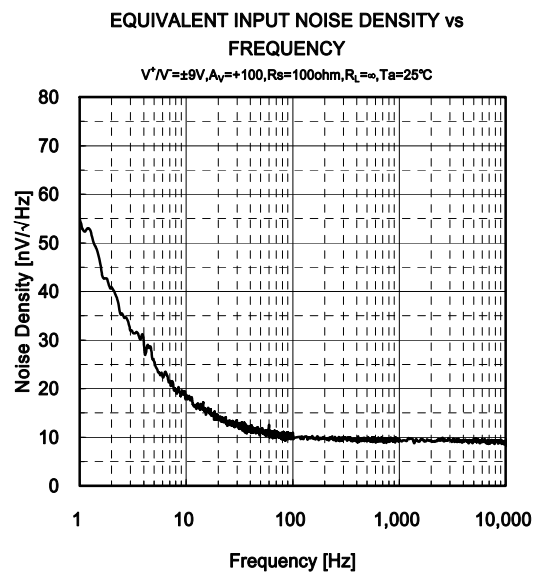
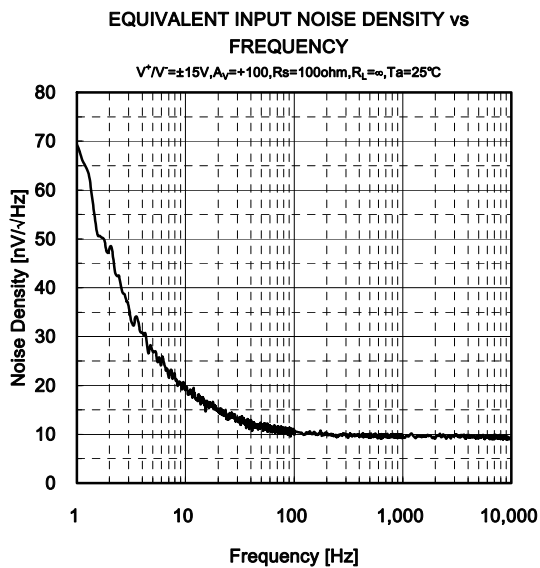
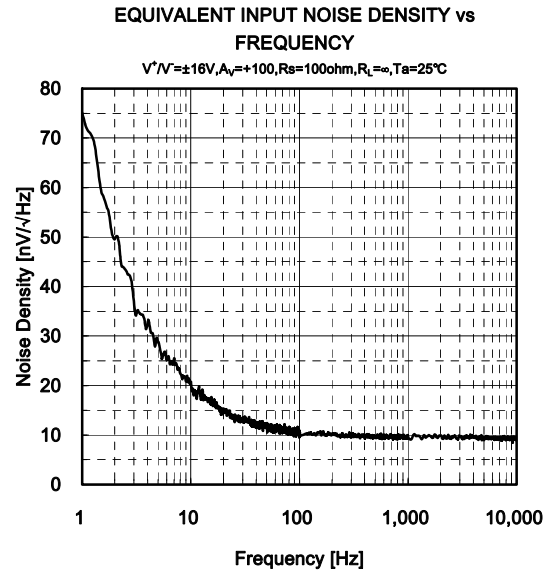
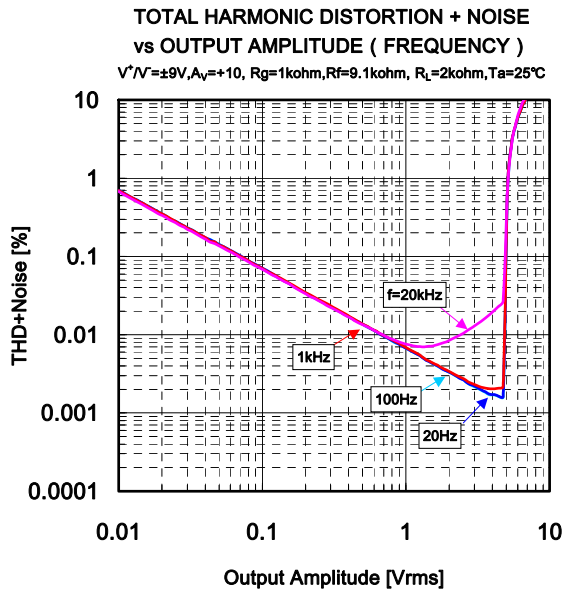
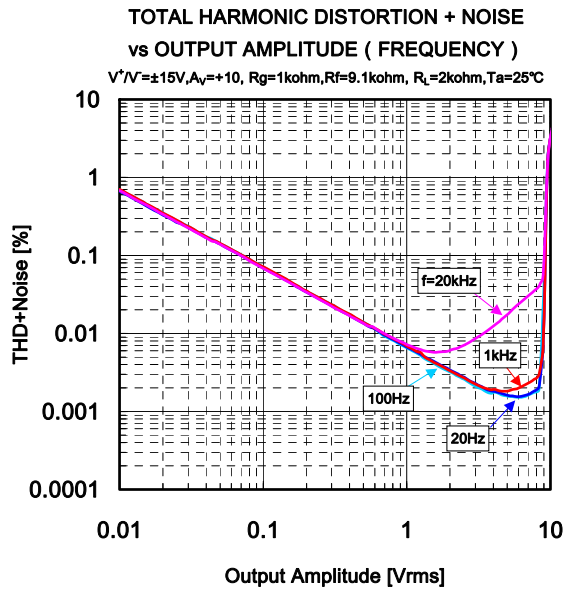
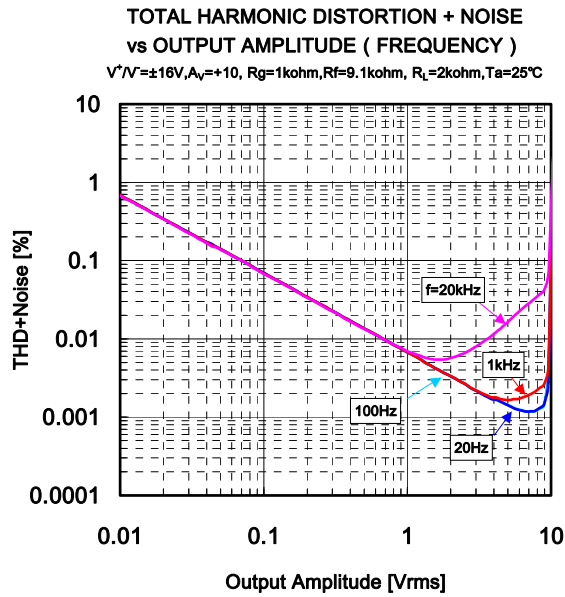
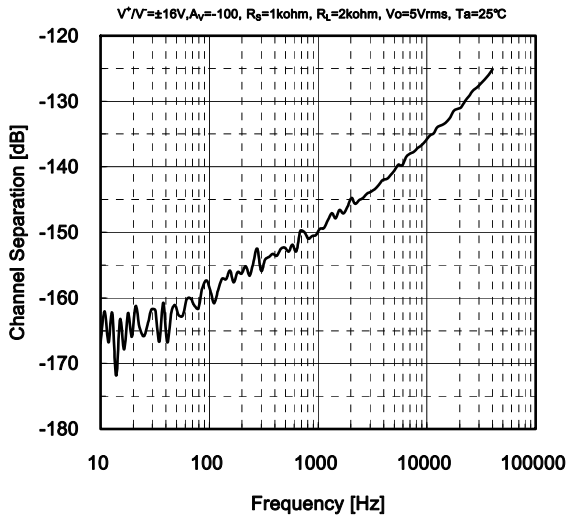

Fig.1 Power Dissipations vs. Ambient Temperature on the MUSES01

■ TYPICAL CHARACTERISTICS



CHANNEL SEPARATION vs FREQUENCY



CHANNEL SEPARATION vs FREQUENCY

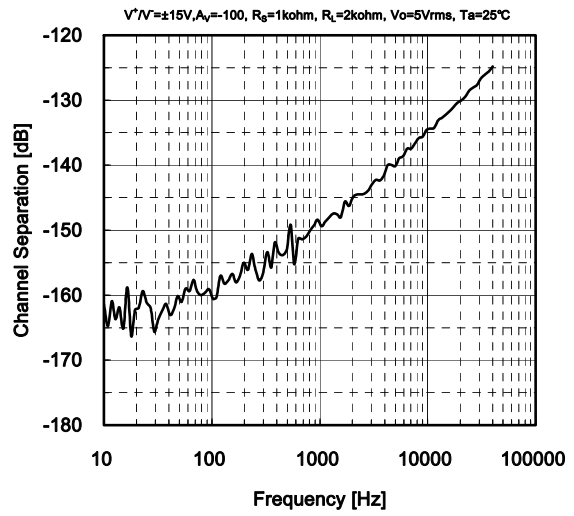

CHANNEL SEPARATION vs FREQUENCY

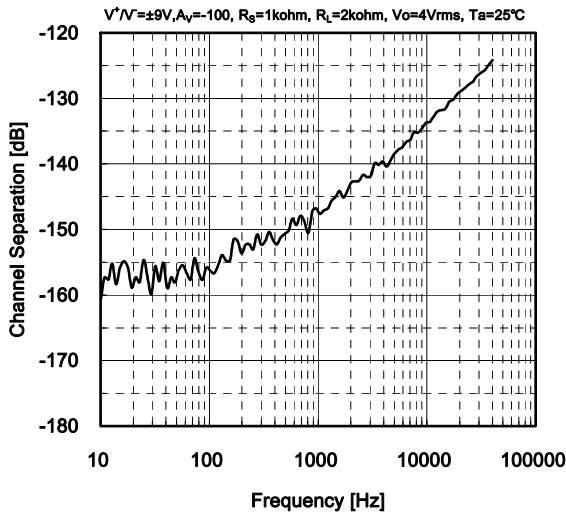

CLOSED-LOOP GAIN/PHASE vs FREQUENCY (TEMPERATURE)

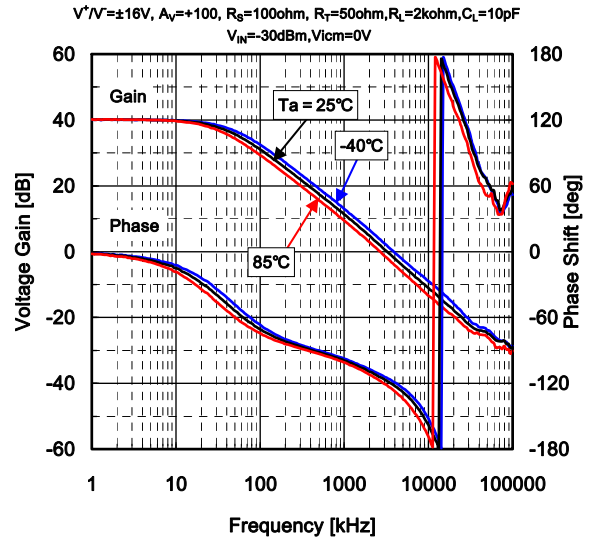

CLOSED-LOOP GAIN/PHASE vs FREQUENCY (TEMPERATURE)

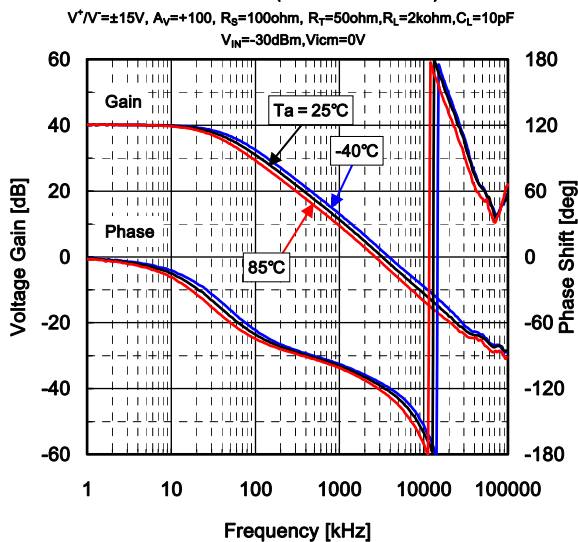

CLOSED LOOP GAIN/PHASE vs FREQUENCY (TEMPERATURE)

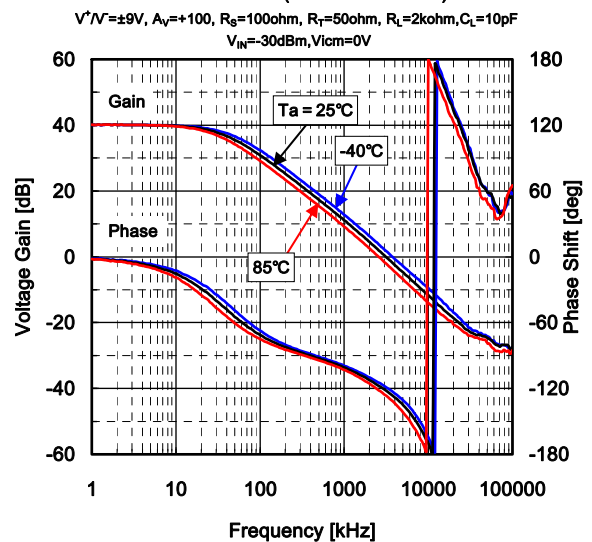

TRANSIENT RESPONSE (TEMPERATURE)

$V^+ / V^- = \pm 16V, V_{IN} = 2V_{P-P}, f = 100kHz$

PulseEdge=10nsec, Gv=0dB, $C_L = 10pF, R_L = 2kohm$

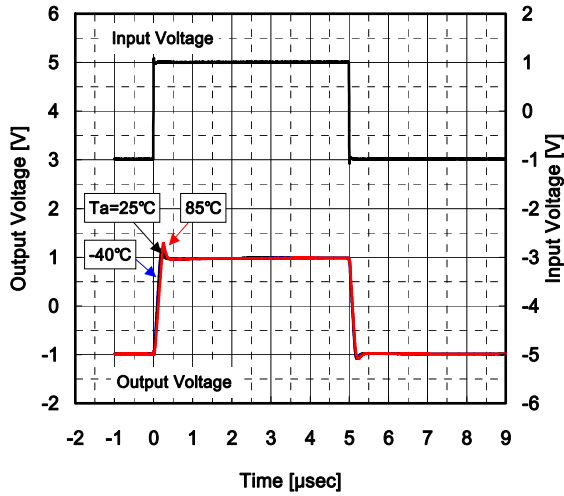

SLEW RATE vs TEMPERATURE

$V^+ / V^- = \pm 16V, V_{IN} = 2V_{P-P}, f = 100kHz$

PulseEdge=10nsec, Gv=0dB, $C_L = 10pF, R_L = 2kohm$

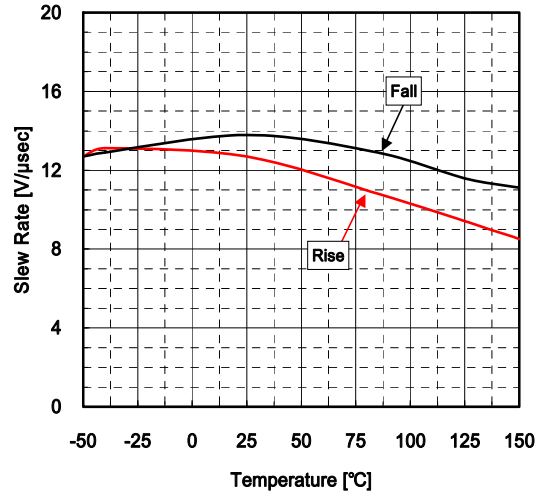

TRANSIENT RESPONSE (TEMPERATURE)

$V^+ / V^- = \pm 15V, V_{IN} = 2V_{P-P}, f = 100kHz$

PulseEdge=10nsec, Gv=0dB, $C_L = 10pF, R_L = 2kohm$

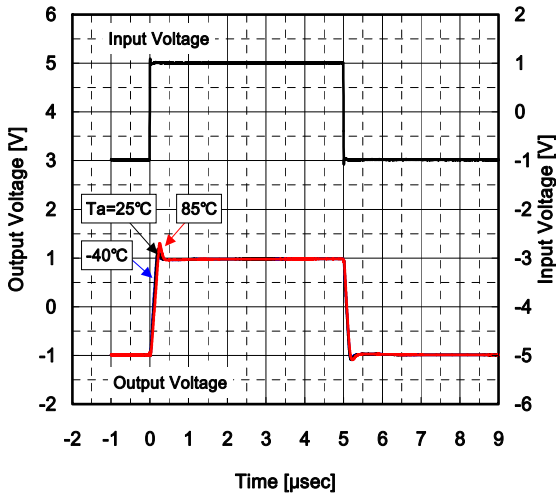

SLEW RATE vs TEMPERATURE

$V^+ / V^- = \pm 15V, V_{IN} = 2V_{P-P}, f = 100kHz$

PulseEdge=10nsec, Gv=0dB, $C_L = 10pF, R_L = 2kohm$

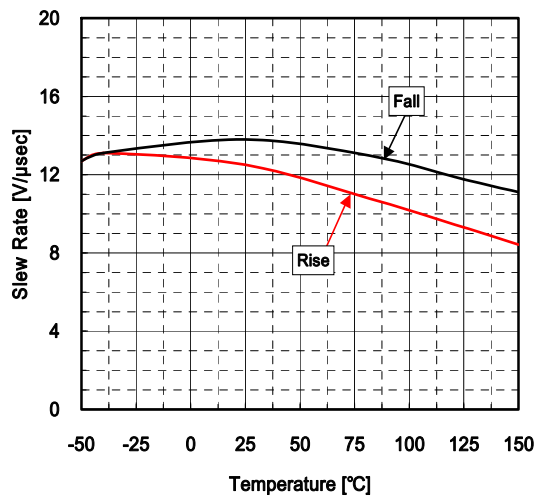

TRANSIENT RESPONSE (TEMPERATURE)

$V^+ / V^- = \pm 9V, V_{IN} = 2V_{P-P}, f = 100kHz$

PulseEdge=10nsec, Gv=0dB, $C_L = 10pF, R_L = 2kohm$

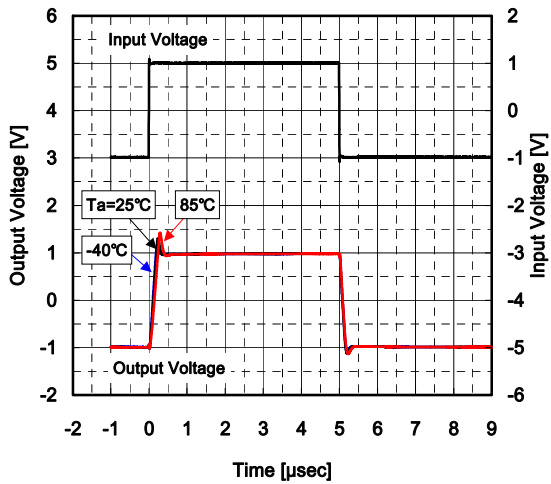

SLEW RATE vs TEMPERATURE

$V^+ / V^- = \pm 9V, V_{IN} = 2V_{P-P}, f = 100kHz$

PulseEdge=10nsec, Gv=0dB, $C_L = 10pF, R_L = 2kohm$

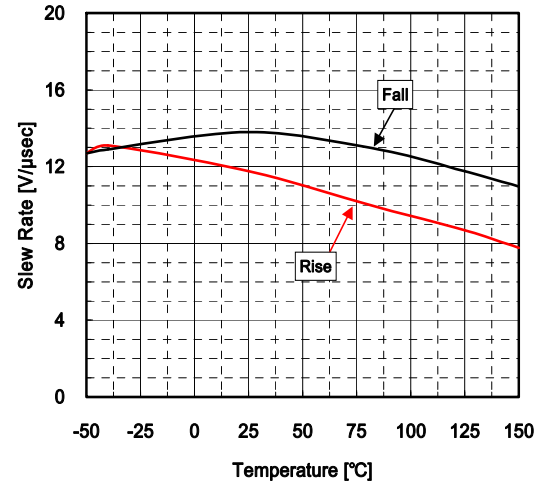

SUPPLY CURRENT vs SUPPLY VOLTAGE
(TEMPERATURE)
 $G_V=0dB, V_{IN}=0V$

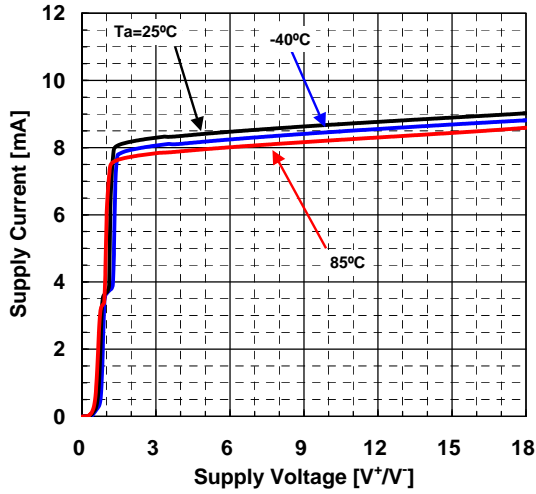

SUPPLY CURRENT vs TEMPERATURE
(SUPPLY VOLTAGE)
 $G_V=0dB, V_{IN}=0V$

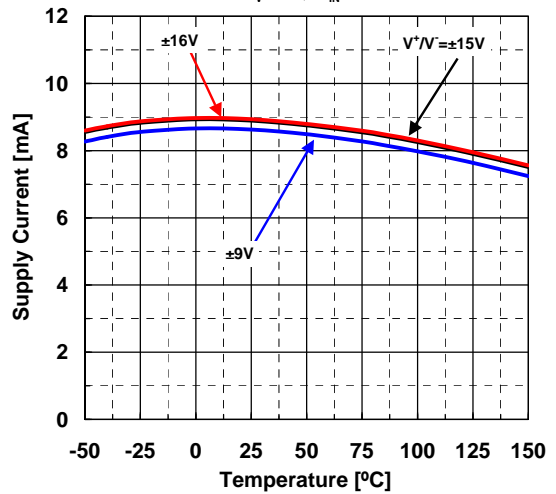

INPUT OFFSET VOLTAGE vs SUPPLY VOLTAGE
(TEMPERATURE)
 $V_{ICM}=0V, V_{IN}=0V$

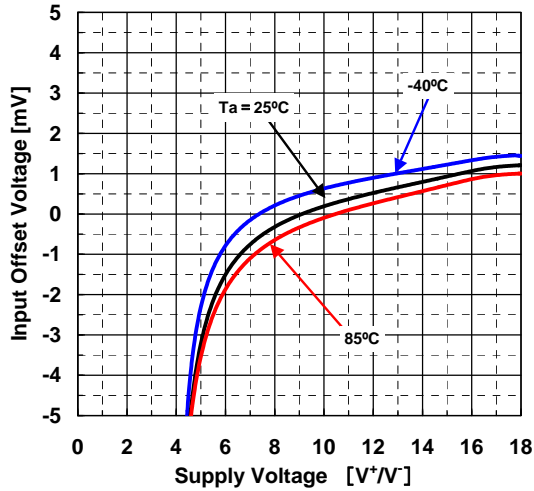

POWER SUPPLY REJECTION RATIO vs TEMPERATURE

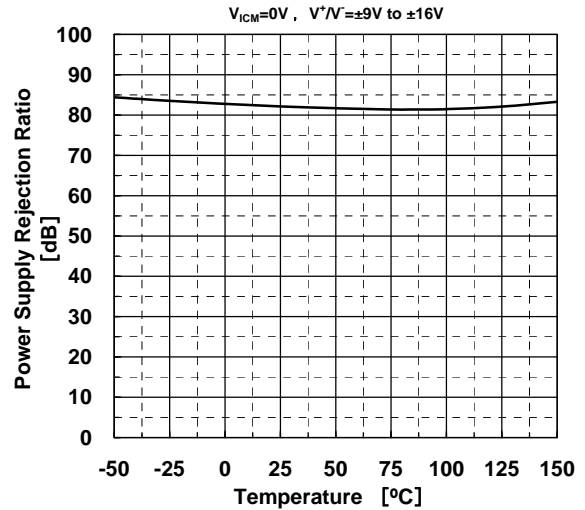

INPUT OFFSET CURRENT vs TEMPERATURE
(SUPPLY VOLTAGE)
 $V_{ICM}=0V$

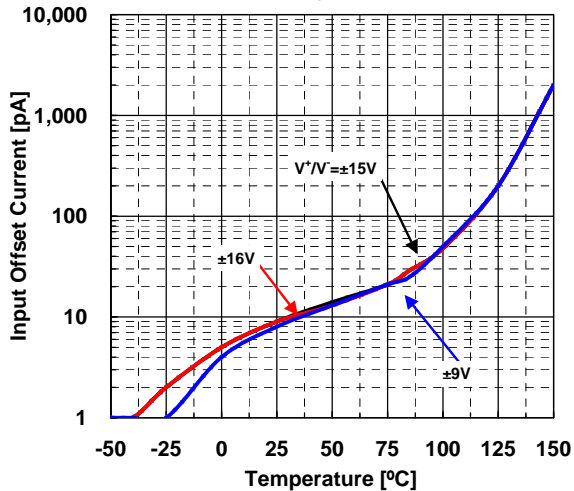

INPUT BIAS CURRENT vs INPUT COMMON-MODE VOLTAGE
(TEMPERATURE)
 $V^*/V=\pm 16V$

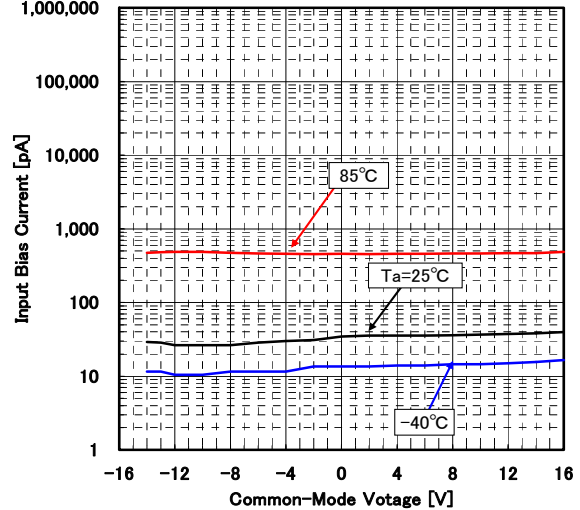

INPUT BIAS CURRENT vs INPUT COMMON-MODE VOLTAGE (TEMPERATURE)

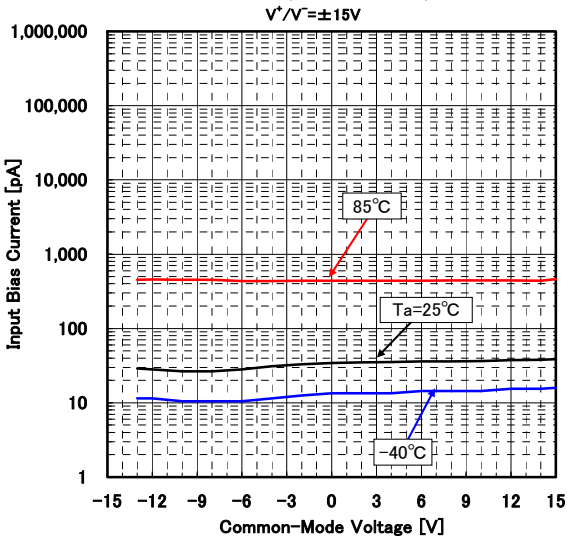

INPUT BIAS CURRENT vs INPUT COMMON-MODE VOLTAGE (TEMPERATURE)

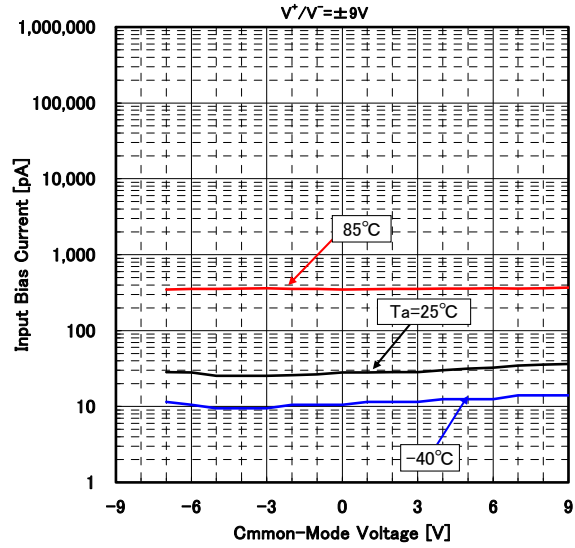

INPUT OFFSET CURRENT vs TEMPERATURE (SUPPLY VOLTAGE)

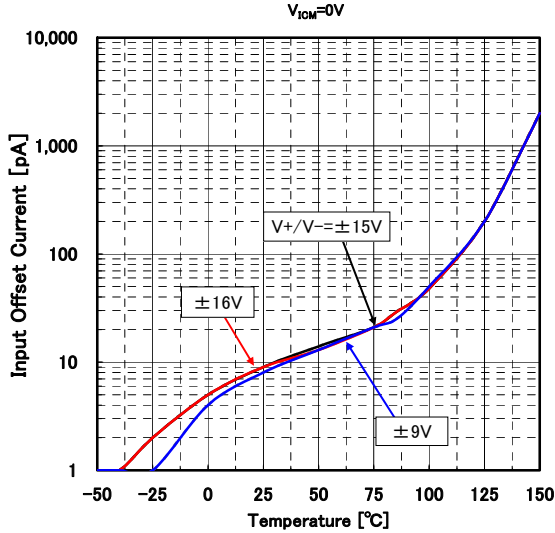

INPUT OFFSET VOLTAGE vs OUTPUT VOLTAGE (TEMPERATURE)

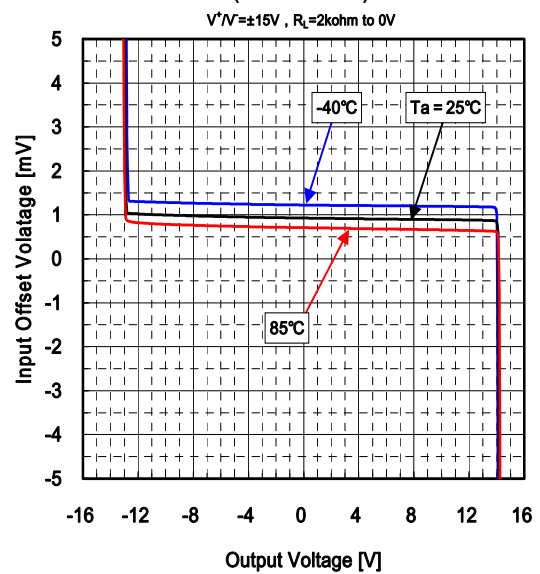

OPEN-LOOP VOLTAGE GAIN vs TEMPERATURE

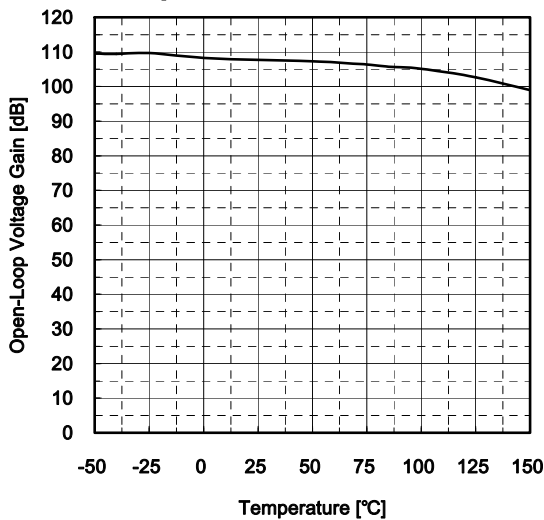

OPEN-LOOP VOLTAGE GAIN vs TEMPERATURE

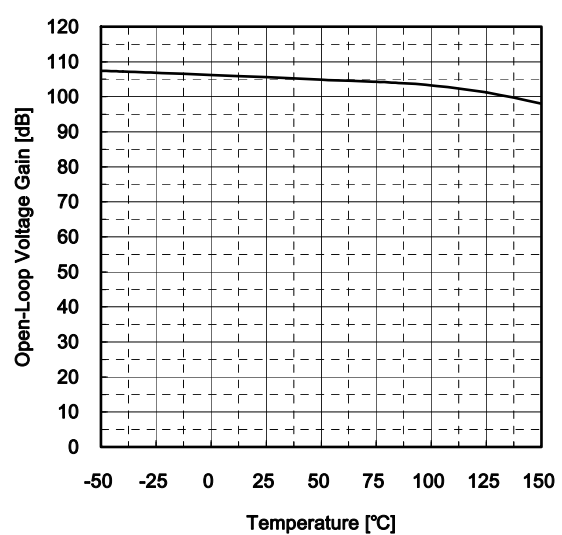

MUSES01

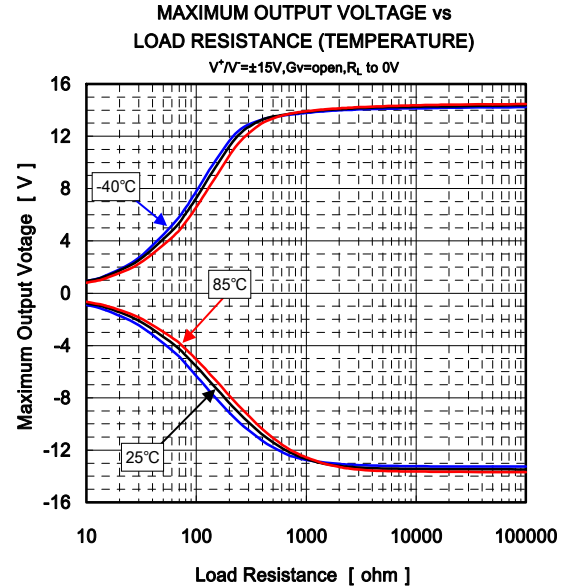
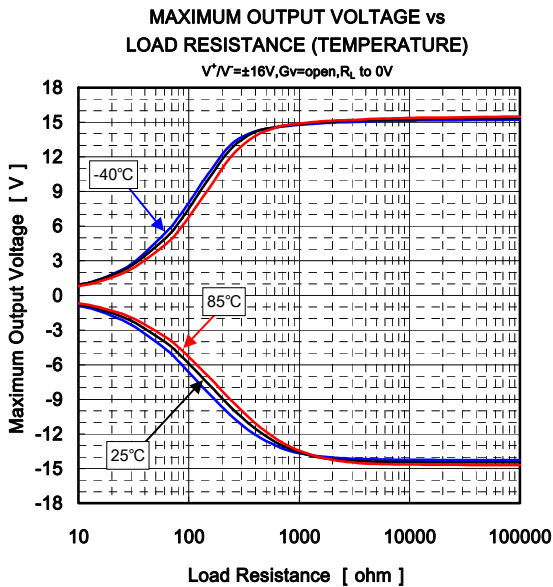
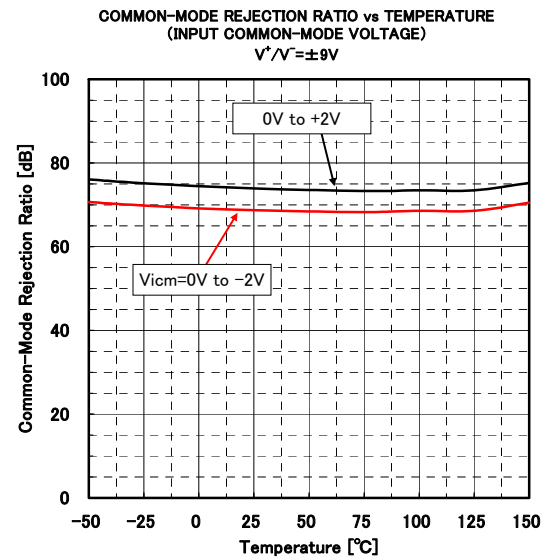
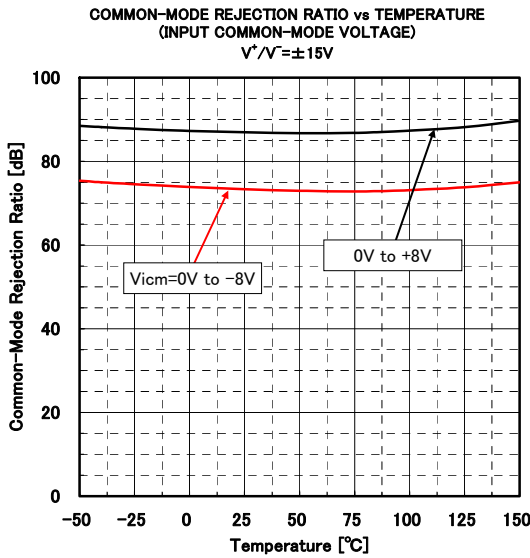
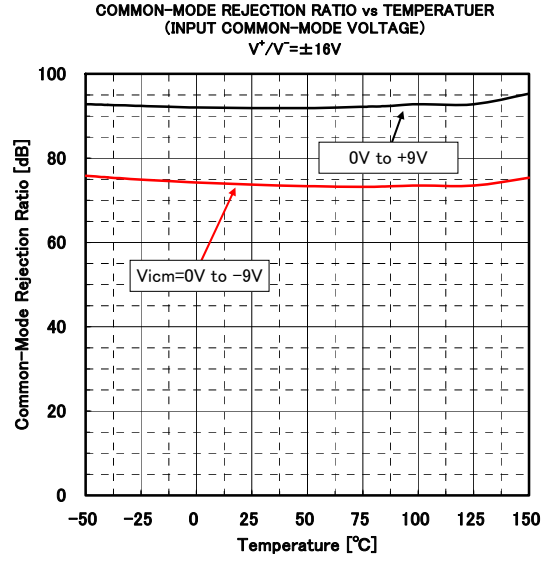
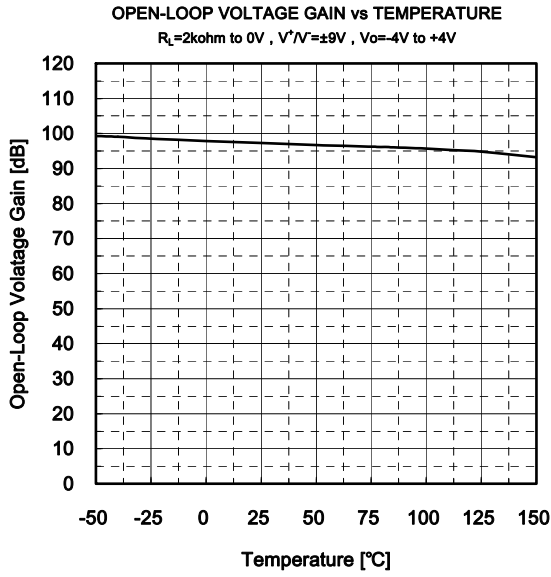

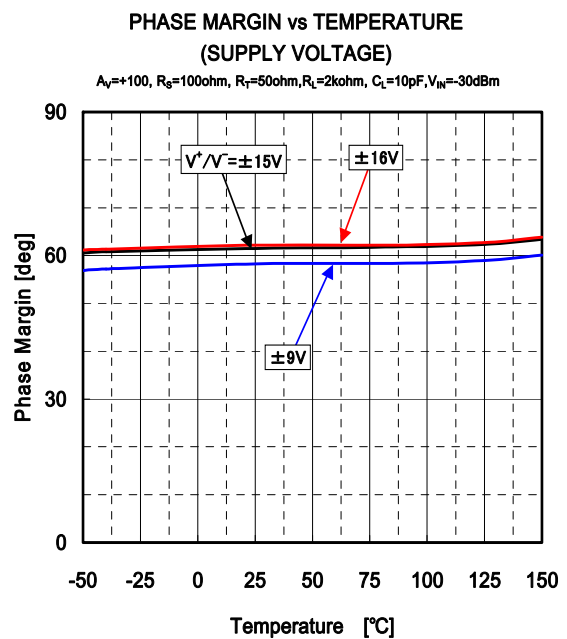
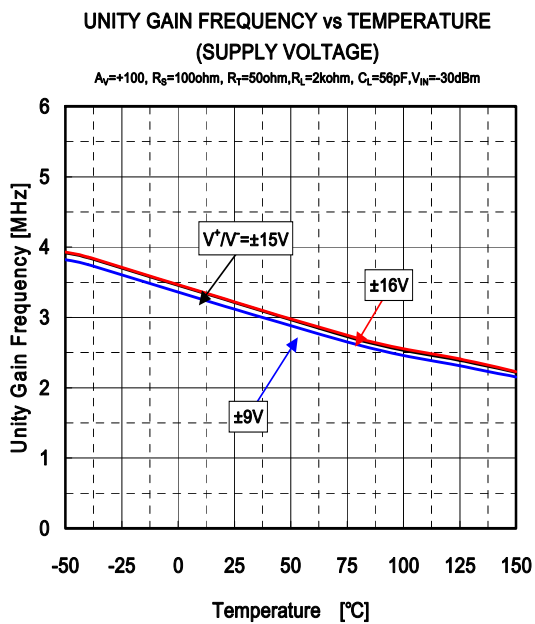
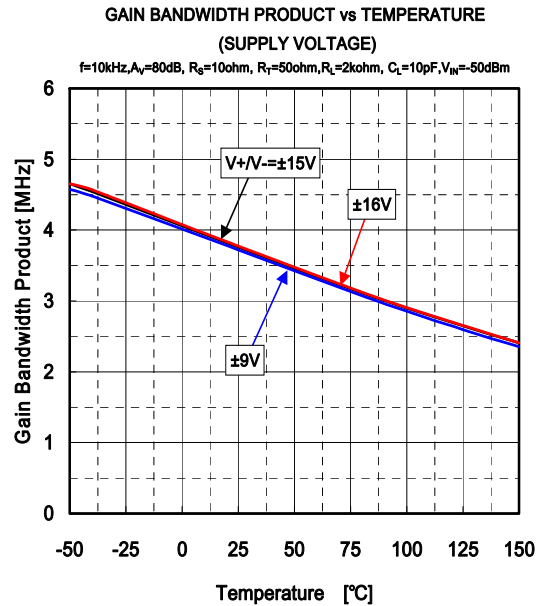
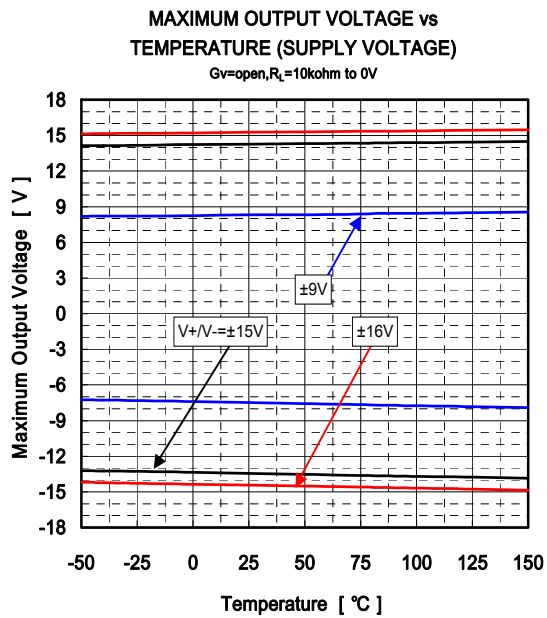
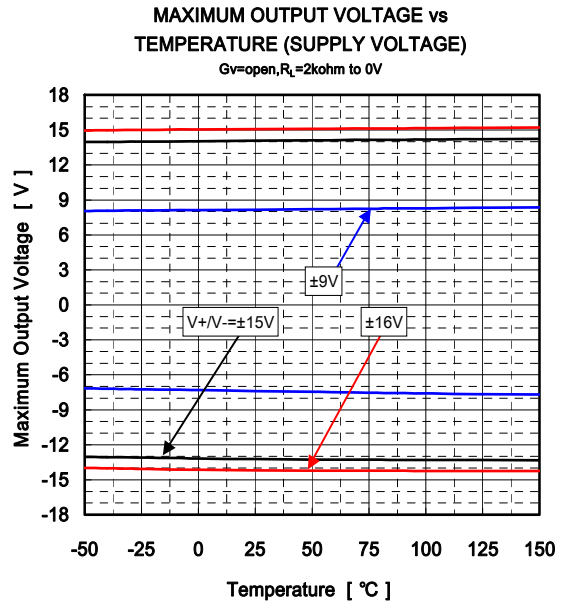
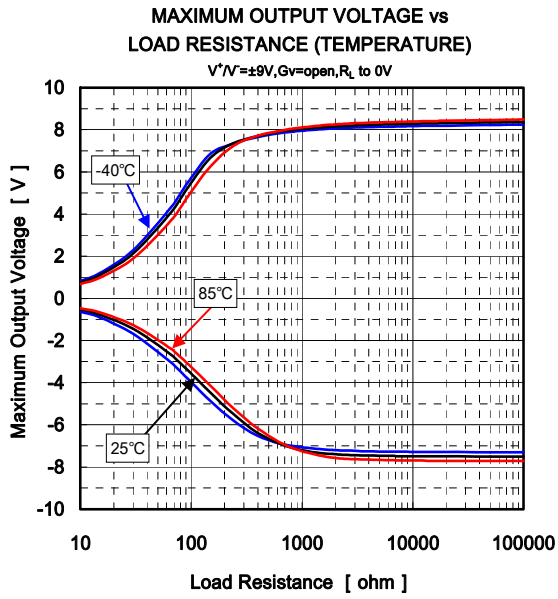

MEMO

[CAUTION]

The specifications on this databook are only given for information, without any guarantee as regards either mistakes or omissions. The application circuits in this databook are described only to show representative usages of the product and not intended for the guarantee or permission of any right including the industrial rights.